

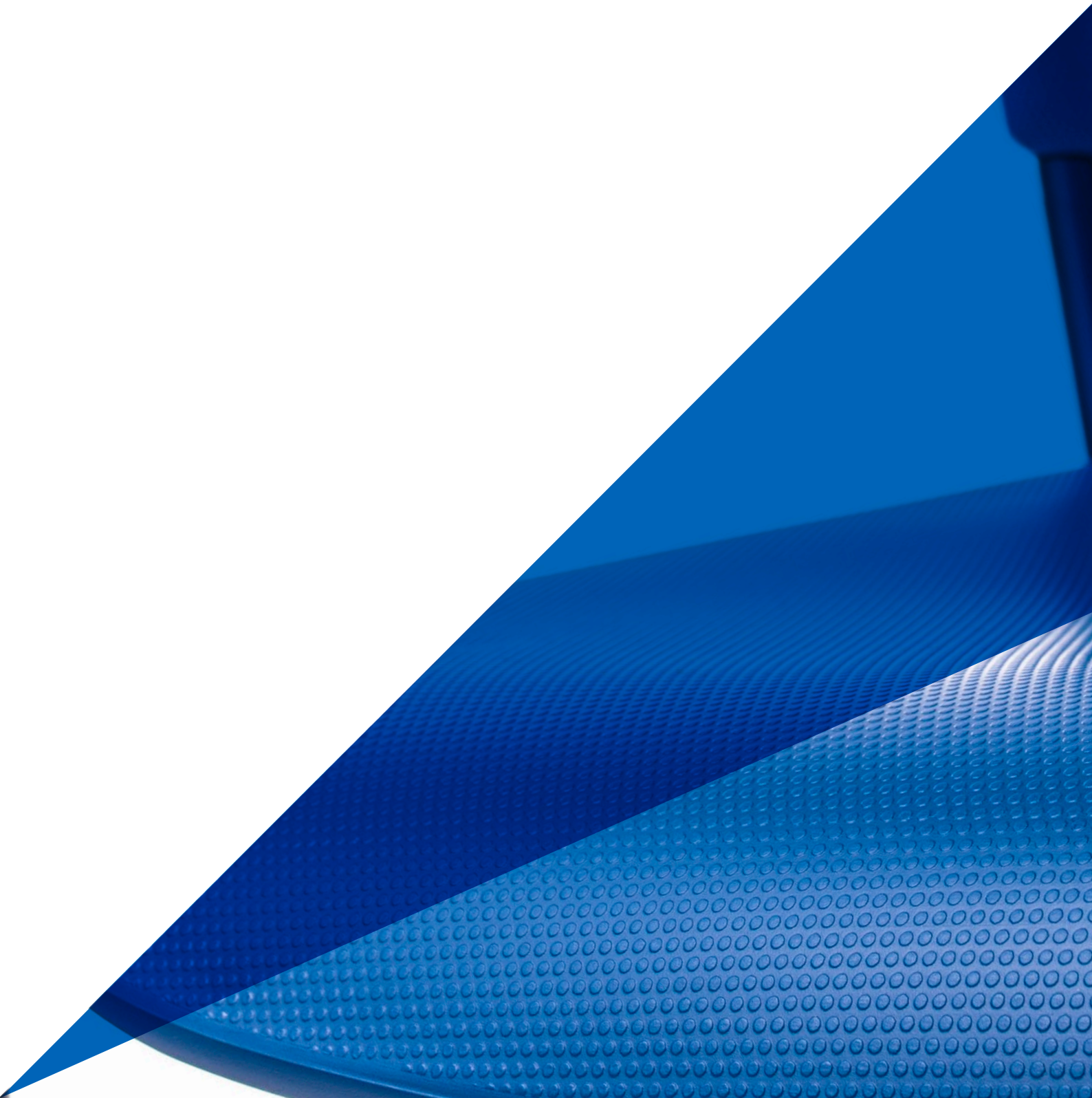

Visitor, Training &
Beam seating

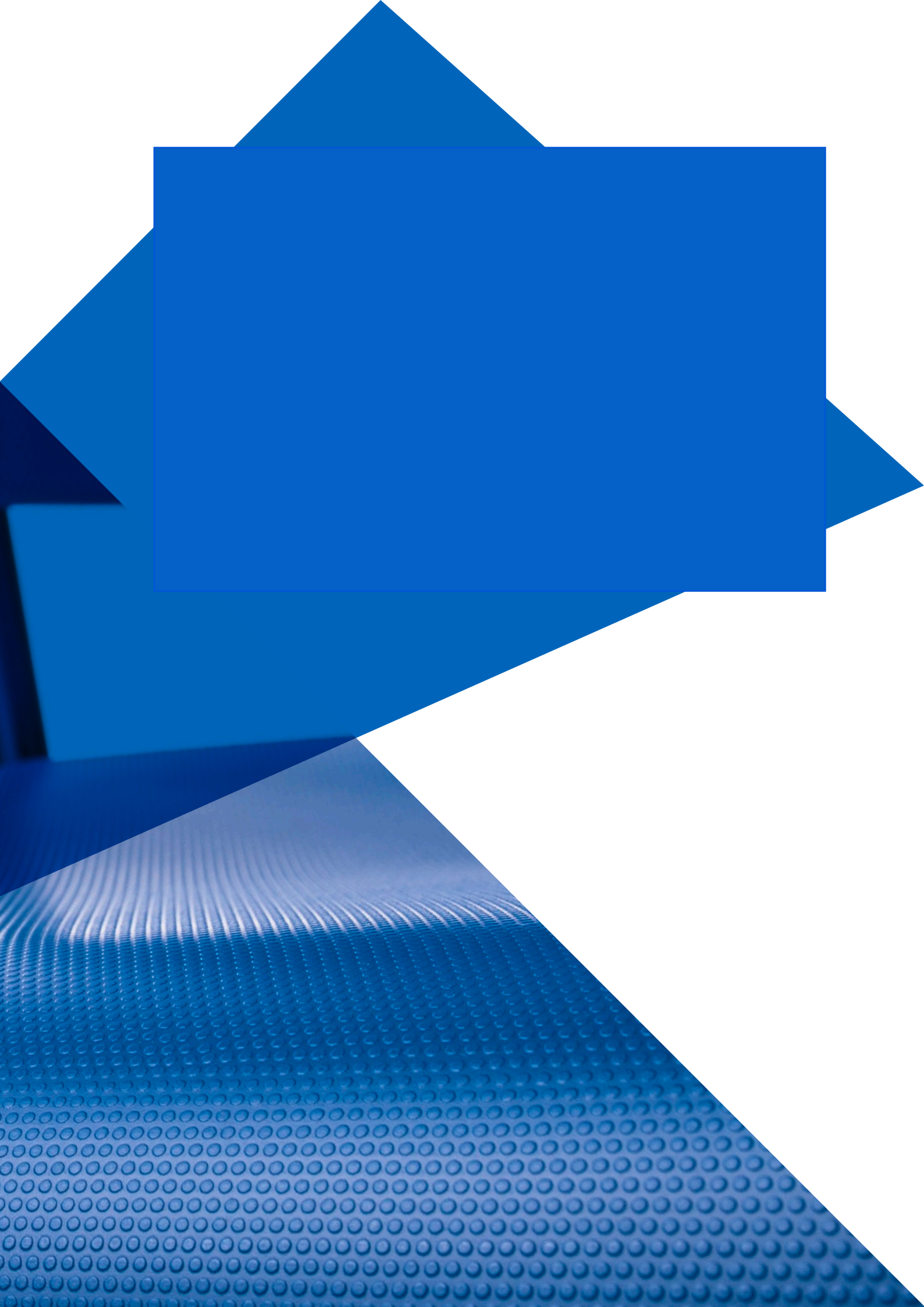



VISITOR



LEAF
PG. 6



CARMEN
PG. 7



SPECTRUM
PG. 8



TECTON
CANTILEVER
PG. 9



TECTON
FOUR LEGS
PG. 10



TURANDOT
CANTILEVER
PG. 11



JIM
PG. 12



JIM SWIVEL
PG. 14

TRAINING



TESS
PG. 18



TURANDOT
PG. 20



TURANDOT
UPHOLSTERED
PG. 21



TURANDOT
MESH
PG. 22



TURANDOT
WOOD
PG. 23



TOSCA
UPHOLSTERED
PG. 24



TOSCA
PG. 25



TOSCA WOOD
PG. 26



MANON
PG. 27



ANITA
PG. 28



SAMMY
PG. 29



ARCA MESH
PG. 30



ARCA
PG. 31



AMBA
PG. 32



JIM
PG. 33



KAI
PG. 34



DIRECTOR
PG. 13

BEAM SEATING



TOSCA BEAM
PG. 38



TURANDOT BEAM
PG. 39



TESS BEAM
PG. 40

VISITORS





LEAF

Elegance and comfort are the key elements of this guest chair whose uses range from office to waiting or meeting areas. The seat is made of cold-cure polyurethane foam and the plywood inner back is padded cut foam. Chrome plated cantilever base made of steel tube \varnothing 25 mm with polypropylene armrests

Elementi chiave di questa sedia ospiti sono l'eleganza ed il comfort, e le molteplici applicazioni includono l'ufficio e le zone di attesa fino alle sale riunioni. Il sedile è realizzato in poliuretano schiumato a freddo e lo schienale in legno multistrato è imbottito con gomma tagliata da blocco. La base cantilever in tubo di acciaio asform \varnothing 25 mm è cromata e dotata di appoggiabraccia in polipropilene.

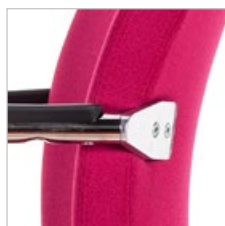

Backrest
Schienale

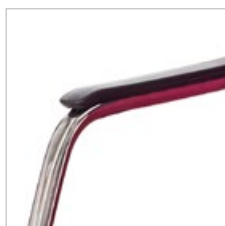

Armrests
Braccioli

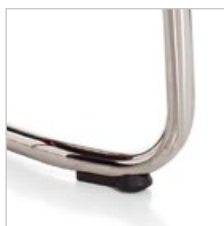

Glides
Piedini

DIMENSIONS

W.56 - D.60 - H.86, H.seat 45 cm



TECHNICAL NOTES

- plywood back padded with flexible polyurethane foam
- cold-cure polyurethane seat with plastic insert.
- \varnothing 25 mm steel tube, chrome plated cantilever base
- polypropylene armrests
- polypropylene non-tipping glides
- *schienale in legno multistrato con imbottitura in gomma tagliata da blocco*
- *sedile in poliuretano schiumato a freddo con inserto in plastica*
- *base cantilever in tubo di acciaio \varnothing 25 mm, cromata*
- *braccioli in polipropilene*
- *piedini anti-ribaltamento in polipropilene*

CARMEN

DIMENSIONS

W.56 - D.57 - H.85, H.seat 45 cm



Up to date, elegant visitor's chair which has universal appeal and fits well into most office environments. Equally suited to meeting and breakout areas or to private waiting areas. Seat and back made of cold-cure polyurethane foam. Chrome plated cantilever base made of steel tube \varnothing 25 mm with polypropylene armrests

Elegante ed attuale, Carmen è una sedia ospiti ideale per ufficio, sale riunioni o a piccole zone d'attesa. Sedile e schienale sono realizzati in poliuretano schiumato a freddo. La base cantilever in tubo di acciaio asform \varnothing 25 mm è cromata e dotata di appoggiabraccia in polipropilene.

TECHNICAL NOTES

- cold-cure polyurethane back with plastic insert
- cold-cure polyurethane seat with plastic insert.
- \varnothing 25 mm steel tube, chrome plated cantilever base
- polypropylene armrests
- polypropylene non-tipping glides
- *schienale in poliuretano schiumato a freddo con inserto in plastica*
- *sedile in poliuretano schiumato a freddo con inserto in plastica*
- *base cantilever in tubo di acciaio \varnothing 25 mm, cromata*
- *braccioli in polipropilene*
- *pie dini anti-ribaltamento in polipropilene*

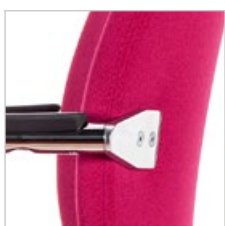

Backrest
Schienale

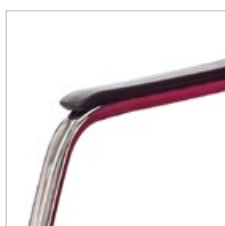

Armrests
Braccioli

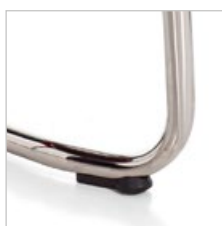

Glides
Piedini

SPECTRUM

Guest chair with mesh back and seat made of cold-cure polyurethane foam. Chrome plated cantilever base made of steel tube \varnothing 25 mm with polypropylene armrests.

Sedia ospiti con schienale in rete e sedile in poliuretano schiumato a freddo. Base cantilever in tubo di acciaio asform \varnothing 25 mm cromato con appoggiabraccia in polipropilene.

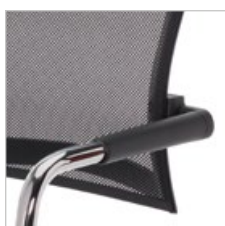

Mesh back
Schienale in rete



Armrests
Braccioli

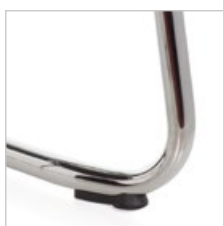

Glides
Piedini

DIMENSIONS





W.56 - D.56 - H.83, H.seat 45 cm



TECHNICAL NOTES

- mesh back with polypropylene framework
- cold-cure polyurethane seat with plastic insert.
- \varnothing 25 mm steel tube, chrome plated cantilever base
- polypropylene armrests
- polypropylene non-tipping glides
- *schienale in rete con struttura di supporto in polipropilene*
- *sedile in poliuretano schiumato a freddo con inserto in plastica*
- *base cantilever in tubo di acciaio \varnothing 25 mm, cromata*
- *braccioli in polipropilene*
- *piedini anti-ribaltamento in polipropilene*

MESH COLOURS

-  R05 - BLACK
-  R09 - RED
-  R07 - WHITE
-  R08 - GREY

TECTON CANTILEVER

DIMENSIONS

W.61 - D.58 - H.82, H.seat 45 cm



Visitor's chair, ideal also in meeting or conference areas. The hi-tech textured plastic back with perforations is easily transformed with an upholstery panel to give further comfort while still maintaining a sharp image.

The cantilever base is available in black, grey or chrome plated finish.

Sedia ospiti, ideali anche per sale riunioni o sale conferenza. Lo schienale in polipropilene con fori per la traspirazione può essere facilmente trasformato con l'aggiunta di un pannellino imbottito per ottenere ulteriore comfort mantenendo una linea affusolata.

La base cantilever è disponibile verniciata nero, grigio o cromata.

TECHNICAL NOTES

- perforated polypropylene back with optional panel
- cold-cure polyurethane seat foam
- polypropylene under seat
- Ø 25 mm steel tube, chrome plated cantilever base
- polypropylene armrests
- polypropylene non-tipping glides

- *schienale in polipropilene traforato con pannello opzionale*
- *cuscino sedile in poliuretano schiumato a freddo*
- *sottosedile in polipropilene*
- *base cantilever in tubo di acciaio Ø 25 mm, cromato*
- *braccioli in polipropilene*
- *piedini anti-ribaltamento in polipropilene*



Perforated backrest
Schienale traforato

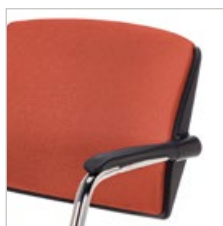

Upholstered backrest
Schienale tappezzato

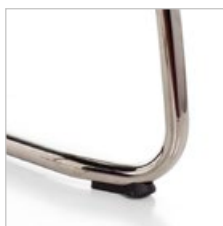

Glides
Piedini

TECTON FOUR LEGS

Visitor's chairs, ideal also in meeting or conference areas. The hi-tech textured plastic back with perforations is easily transformed with an upholstery panel to give further comfort while still maintaining a sharp image. The four legged base can be assembled with glides or castors. Black, grey or chrome plated finish.

Sedie ospiti, ideali anche per sale riunioni o sale conferenza. Lo schienale in polipropilene con fori per la traspirazione può essere facilmente trasformato con l'aggiunta di un pannellino imbottito per ottenere ulteriore comfort mantenendo una linea affusolata. La base a quattro gambe può essere assemblata con piedini o ruote. Finitura nera, grigia o cromata.

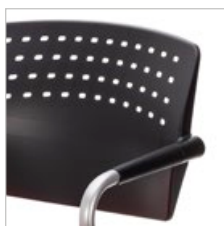

Perforated backrest
Schienale traforato



Upholstered backrest
Schienale tappezzato



Castors
Ruote

DIMENSIONS

W.58 - D.59 - H.85, H.seat 45 cm



TECHNICAL NOTES

- perforated polypropylene back with optional panel
- cold-cure polyurethane seat foam
- polypropylene under seat
- Ø 25 mm steel tube, four leg base
- polypropylene armrests
- polypropylene glides or castors
- *schienale in polipropilene traforato con pannello opzionale*
- *cuscinio sedile in poliuretano schiumato a freddo*
- *sottosedile in polipropilene*
- *base quattro gambe in tubo di acciaio Ø 25 mm*
- *braccioli in polipropilene*
- *piedini o ruote in polipropilene*

TURANDOT CANTILEVER

Guest chair with three different types of backrest: plastic, upholstered or mesh back. For each version the upholstered seat is standard and armrest optional. Chrome plated cantilever base made of steel tube \varnothing 25 mm with polypropylene armrests.

Sedia ospiti disponibile con tre diverse varianti di schienale: plastica a vista, imbottito o rete. Tutte le versioni sono dotate di sedile imbottito e braccioli opzionali. Base cantilever in tubo di acciaio asform \varnothing 25 mm cromato con appoggiabraccia in polipropilene.



Plastic backrest
Schienale in plastica



Upholstered backrest
Schienale tappezzato

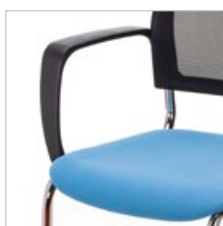

Armrests
Braccioli

DIMENSIONS





Without arms:
W.50 - D.57 - H.85, H.seat 45 cm
With arms:
W.63 - D.57 - H.85, H.seat 45 cm



TECHNICAL NOTES

- mesh back / polypropylene back with optional panel
- polypropylene seat to upholsterer
- \varnothing 25 mm steel tube, chrome plated cantilever base
- polypropylene non-tipping feet
- optional polypropylene armrests
- *schienale in rete / schienale in polipropilene con pannello opzionale*
- *sedile in polipropilene da tappezzare*
- *base cantilever in tubo di acciaio \varnothing 25 mm, cromato*
- *pedini anti-ribaltamento in polipropilene*
- *braccioli in polipropilene opzionali*

MESH COLOURS

-  R05 - BLACK
-  R09 - RED
-  R07 - WHITE
-  R08 - GREY

JIM



Lightweight yet distinctive and fluid in its design, Jim has a colorful polypropylene shell that can be enriched by a soft panel for the seat. The model is available in many variants: with polypropylene shell with or without armrests, with natural varnished beech wood base, with chromed or wooden four legs.

Sedia leggera, dalle linee fluide ma di forte personalità, Jim ha una scocca in polipropilene colorato che può essere arricchita da un morbido cuscino per il sedile. Il modello è disponibile in numerose varianti: con scocca in polipropilene con o senza braccioli, con scocca in faggio verniciato naturale, con base a quattro gambe cromata oppure in legno.

DIMENSIONS

W.61 - D.52 - H.80, H.seat 47 cm



TECHNICAL NOTES

- polypropylene shell with optional seat panel
- 20 mm steel tube four leg base
- scocca in polipropilene con pannello sedile opzionale
- base quattro gambe in tubo d'acciaio 20 mm

PLASTIC COLOURS

	018 - WHITE
	040 - VANILLA
	013 - SKY BLUE
	028 - GREEN
	038 - ORANGE
	031 - RED
	021 - ANTHRACITE
	039 - CHOCOLATE
	004 - PURPLE



Stackable
Impilabile



Seat cushion
Pannello sedile

JIM WOOD



Lightweight yet distinctive and fluid in its design, Jim has a colorful polypropylene shell that can be enriched by a soft upholstered panel for the seat. With a four leg base made of solid wood Jim chair is especially suitable for home and contract.

Sedia leggera, dalle linee fluide ma di forte personalità, Jim ha una scocca in polipropilene colorato che può essere arricchita da un morbido cuscino per il sedile. Con la base a quattro gambe in legno massello la sedia Jim risulta particolarmente adatta per ambiente casa e contract.



Seat cushion
Pannello sedile

DIMENSIONS

W.61 - D.52 - H.83, H.seat 47 cm



TECHNICAL NOTES

- polypropylene shell with optional seat panel
- four leg wooden base
- scocca in polipropilene con pannello sedile opzionale
- base quattro gambe in legno massello

PLASTIC COLOURS

	018 - WHITE
	040 - VANILLA
	013 - SKY BLUE
	028 - GREEN
	038 - ORANGE
	031 - RED
	021 - ANTHRACITE
	039 - CHOCOLATE
	004 - PURPLE

JIM



Lightweight yet distinctive and fluid in its design, Jim has a colorful polypropylene shell that can be enriched by a soft upholstered panel for the seat. The swivel chair is notable for the high quality of the five star chrome base, available with hard castors or rubber castors for soft floors such as parquet or ceramic tiles.

Sedia leggera, dalle linee fluide ma di forte personalità, Jim ha una scocca in polipropilene colorato che può essere arricchita da un morbido cuscino tappezzato per il sedile. La versione girevole si contraddistingue per l'alta qualità della base a cinque razze cromata, disponibile con ruote rigide o ruote gommate per superfici morbide come parquet o piastrelle in ceramica.



Seat cushion
Pannello sedile



Gas lift
Alzata a gas

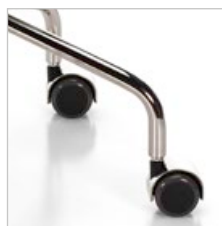

Soft castors
Ruote gommate

DIMENSIONS

W.60 - D.58 - H.78/81
H.seat 45/58 cm



TECHNICAL NOTES

- polypropylene shell with optional seat panel
- polypropylene under seat
- gas lift with lever
- chrome plated swivel base
- 50 mm pivoting castors
- *scocca in polipropilene con pannello opzionale*
- *sottoseduta in polipropilene*
- *alzata a gas con leva*
- *base girevole cromata*
- *ruote piroettanti da 50 mm*

PLASTIC COLOURS

	018 - WHITE
	040 - VANILLA
	013 - SKY BLUE
	028 - GREEN
	038 - ORANGE
	031 - RED
	021 - ANTHRACITE
	039 - CHOCOLATE
	004 - PURPLE



TRAINING





TESS



DIMENSIONS

Without arms:

W.48 - D.51 - H.85, H.seat 45 cm

With arms:

W.55 - D.51 - H.85, H.seat 45 cm



Tess is designed to suit a wide variety of uses and contexts. Matching the shell with different base and accessories, the product expresses its full potential while maintaining its own elegant identity and comfort. Lively in more vibrant colours,

Tess è stata progettata per adattarsi a un'ampia varietà di utilizzi e contesti. Con la base e gli accessori con cui la seduta viene abbinata, il prodotto esprime le sue potenzialità mantenendo l'elegante identità e il comfort che gli sono propri. Briosà nei colori più vivaci.



Chair with arms v.1
Sedia con braccioli v1



Chair with arms v.2
Sedia con braccioli v2



Chair with arms v.3
Sedia con braccioli v3



Sled chair
Sedia a slitta



Anti-panic oval tablet
Tavoletta antipanico ovale



Anti-panic square tablet
Tavoletta anti-panico quadrata



Student tablet
Tavoletta studenti



Swivel chair with arms
Sedia girevole con braccioli



Swivel chair
Sedia girevole

Tess is particularly refined in light colours. In the classic version with four legs, it is a multipurpose stackable chair suitable for public activities such as training, meeting and conference rooms. In the swivel version, with or without upholstered panel, it becomes a lightweight and handy chair, perfect for domestic use.

Tess risulta particolarmente raffinata nelle tinte tenui. Nella classica versione quattro gambe è una sedia polifunzionale impilabile adatta per usi collettivi come aule studio e formazione, sale riunione e conferenza. Nella versione girevole, con o senza pannellino tappezzato in tessuto, diventa una sedia leggera e maneggevole, adatta per un'utenza giovane o contesti domestici.



Bar stool
Sgabello

PLASTIC COLOURS

	018 - WHITE
	073 - LIGHT GREY
	030 - GRAPHITE
	021 - ANTHRACITE
	013 - LIGHT BLUE
	028 - GREEN
	038 - ORANGE
	031 - RED
	003 - CRETE
	004 - PURPLE

TECHNICAL NOTES

- polypropylene shell
- Ø 20 mm steel tube frame
- optional seat panel
- optional bases
 - four leg base
 - four leg base with armrests
 - sled base
 - swivel base
- *scocca in polipropilene*
- *struttura in tubo d'acciaio Ø 20 mm*
- *pannello sedile opzionale*
- *basi opzionali*
 - *base quattro gambe*
 - *base quattro gambe con braccioli*
 - *base a slitta*
 - *base girevole*

TURANDOT



A multifunctional, stackable chair which provides an attractive solution for reception or communication areas, for meeting rooms or training areas. The Turandot chair's design has been carefully studied in every detail to maximise its clean distinctive lines.

Sedia multifunzionale e impilabile che fornisce una soluzione accattivante per reception, sale riunioni e aree di formazione. Il design della sedia Turandot è stato accuratamente studiato in ogni dettaglio per ottimizzare le linee "pulite" che la contraddistinguono.



Seat with arms
Seduta con braccioli



Anti-panic tablet
Tavoletta antipanico



Trolley - chair stackable
up to 10
Carrello - sedia
impilabile fino a 10

DIMENSIONS

Without arms:

W.49 - D.54 - H.80, H.seat 45 cm

With arms:

W.62 - D.54 - H.80, H.seat 45 cm



TECHNICAL NOTES

- polypropylene backrest
- polypropylene seat / under seat
- Ø 22/25 mm steel tube frame
- optional:
 - polypropylene armrests
 - metal armrests
 - anti-panic writing tablet
 - polypropylene linking device
 - castors
- schienale in polipropilene
- sedile / sotto sedile in polipropilene
- struttura in tubo d'acciaio Ø 22/25 mm
- optional
 - braccioli in polipropilene
 - braccioli in metallo
 - tavoletta scrittoio antipanico
 - agganci in polipropilene
 - ruote

PLASTIC COLOURS

- 015 - BLACK
- 073 - LIGHT GREY

FRAME FINISHES

- 015 - BLACK
- 013 - GREY
- 002 - CHROME

ACCESSORIES

See page 43
Vedi pagina 43

TURANDOT UPHOLSTERED



This version is provided with a back panel to upholster and the seat can be easily upholstered without any additional component. For stacking in greater numbers and for transportation, a trolley is available.

Questa versione viene fornita con un pannello schienale da tappezzare mentre il sedile può essere facilmente rivestito senza applicare componenti aggiuntivi. Per facilitarne la movimentazione è disponibile l'apposito carrello.



Seat with arms
Seduta con braccioli



Anti-panic tablet
Tavoletta antipanico



Trolley - chair stackable up to 10
Carrello - sedia impilabile fino a 10

DIMENSIONS

Without arms:

W.45 - D.54 - H.81, H.seat 46 cm

With arms:

W.62 - D.54 - H.81, H.seat 46 cm



TECHNICAL NOTES

- polypropylene backrest with panel
- polypropylene seat to upholsterer
- polypropylene under seat
- Ø 22/25 mm steel tube frame
- optional:
 - polypropylene armrests
 - metal armrests
 - anti-panic writing tablet
 - polypropylene linking device
 - castors
- schienale in polipropilene con pannello
- sedile in polipropilene da tappezzare
- sotto sedile in polipropilene
- struttura in tubo d'acciaio Ø 22/25 mm
- optional
 - braccioli in polipropilene
 - braccioli in metallo
 - tavoletta scrittoio antipanico
 - agganci in polipropilene
 - ruote

FRAME FINISHES

- 015 - BLACK
- 013 - GREY
- 002 - CHROME

ACCESSORIES

See page 43
Vedi pagina 43

TURANDOT MESH



The mesh back version is available with four different colours of mesh: black, white, grey or red. The chair is stackable with or without arms.

Questa versione viene fornita con uno schienale in rete disponibile in quattro diversi colori: nero, bianco, grigio o rosso. La sedia è impilabile con o senza braccioli.



Plastic seat
Sedile in plastica



Plastic seat with arms
Sedile in plastica con braccioli



Trolley - chair stackable up to 10
Carrello - sedia impilabile fino a 10

DIMENSIONS

Without arms:

W.49 - D.54 - H.80, H.seat 46 cm

With arms:





W.62 - D.54 - H.80, H.seat 46 cm



TECHNICAL NOTES

- polypropylene backrest with panel
- polypropylene seat to upholsterer
- polypropylene under seat
- Φ 22/25 mm steel tube frame
- optional:
 - polypropylene armrests
 - metal armrests
 - anti-panic writing tablet
 - polypropylene linking device
 - castors
- schienale in polipropilene con pannello
- sedile in polipropilene da tappezzare
- sotto sedile in polipropilene
- struttura in tubo d'acciaio Φ 22/25 mm
- optional
 - braccioli in polipropilene
 - braccioli in metallo
 - tavoletta scrittoio antipanico
 - agganci in polipropilene
 - ruote

MESH COLOURS

-  R05 - BLACK
-  R09 - RED
-  R07 - WHITE
-  R08 - GREY

FRAME FINISHES

-  015 - BLACK
-  013 - GREY
-  002 - CHROME

ACCESSORIES

See page 43
Vedi pagina 43

TURANDOT WOOD



This version is provided with seat and back in natural varnished plywood. Turandot also has anti-panic writing tablet and linking device.

For all models the legs are available in black, grey or chrome plated finish.

Questa versione viene fornita con sedile e schienale in legno multistrato verniciato naturale. Turandot è dotata inoltre di una tavoletta scrittoio antipanico e di agganci per l'allineamento in fila. Per tutte le versioni le gambe sono disponibili con finitura nera, grigia o cromata.



Anti-panic tablet
Tavoletta antipanico



Trolley - chair stackable
up to 10
Carrello - sedia
impilabile fino a 10

DIMENSIONS

Without arms:

W.49 - D.54 - H.80, H.seat 45 cm

With arms:

W.59 - D.54 - H.80, H.seat 45 cm



TECHNICAL NOTES

- polypropylene backrest
- polypropylene seat / under seat
- Ø 22/25 mm steel tube frame
- optional:
 - polypropylene armrests
 - metal armrests
 - anti-panic writing tablet
 - polypropylene linking device
 - castors
- *schienale in polipropilene*
- *sedile / sotto sedile in polipropilene*
- *struttura in tubo d'acciaio Ø 22/25 mm*
- *optional*
 - *braccioli in polipropilene*
 - *braccioli in metallo*
 - *tavoletta scrittoio antipanico*
 - *agganci in polipropilene*
 - *ruote*

VARNISHED

011 - NATURAL

FRAME FINISHES

015 - BLACK

013 - GREY

002 - CHROME

ACCESSORIES

See page 43
Vedi pagina 43

TOSCA UPHOLSTERED



This classic multifunctional chair is sturdy and robust and comes in upholstered, polypropylene or beech finishes. In addition, the base is available in black, grey or chrome. Shown here in the upholstered version, ideal as a guest or visitor's chair for offices or in meeting areas.

Sedia multifunzionale classica, leggera e resistente, disponibile in tessuto, polipropilene o legno. Base nera, grigia o cromata. Qui proposta nella versione imbottita, risulta ideale come sedia ospiti per l'ufficio o come sedia per le sale riunioni.



Metal arms
Braccioli in metallo



Anti-panic tablet
Tavoletta antipanico



Chair stackable up to 10
Sedia impilabile fino a 10

DIMENSIONS

Without arms:

W.56 - D.62 - H.80, H.seat 49 cm

With arms:

W.69 - D.62 - H.80, H.seat 49 cm



TECHNICAL NOTES

- polypropylene inner / outer seat
- polypropylene inner / outer seat
- flexible polyurethane foams
- 30x15 mm oval steel tube frame
- optional:
 - polypropylene armrests
 - metal armrests
 - metal linking device
 - anti-panic writing table
- *interno/esterno schienale in polipropilene*
- *interno/esterno sedile in polipropilene*
- *gomma tagliata da blocco*
- *struttura in tubo d'acciaio ovale 30x15 mm*
- *optional*
 - *braccioli in polipropilene*
 - *braccioli in metallo*
 - *agganci in metallo estraibili*
 - *tavoletta scrittoio antipanico*

FRAME FINISHES

-  015 - BLACK
-  013 - GREY
-  002 - CHROME

ACCESSORIES

See page 42
Vedi pagina 42

TOSCA



Shown here in the easy-care polypropylene version, ideal as community seating. A wide colour range includes colours that are fire resistant. For arrangements in rows the chairs are linkable, and accessories include an anti-panic writing tablet.

Qui proposta nella versione in polipropilene, Tosca è ideale come sedia per collettività. Un'ampia gamma di colori include anche quelli ignifughi. Le sedie sono agganciabili per la sistemazione in fila. Gli accessori includono anche la tavoletta antipanico.



Plastic arms
Braccioli in plastica



Anti-panic tablet
Tavoletta antipanico



Chair stackable up to 10
Sedia impilabile fino a 10

DIMENSIONS

Without arms:

W.56 - D.62 - H.79, H.seat 46 cm

With arms:

W.69 - D.62 - H.79, H.seat 46 cm



TECHNICAL NOTES

- polypropylene seat and back
- 30x15 mm oval steel tube frame
- optional:
 - polypropylene armrests
 - metal armrests
 - metal linking device
 - anti-panic writing tablet
- *sedile / schienale in polipropilene*
- *struttura in tubo d'acciaio ovale 30x15 mm*
- *optional*
 - *braccioli in polipropilene*
 - *braccioli in metallo*
 - *agganci in metallo estraibili*
 - *tavoletta scrittoio antipanico*

PLASTIC COLOURS

- 042 - BORDEAUX
- 031 - RED
- 079 - DARK GREY
- 015 - BLACK
- 073 - LIGHT GREY*
- 054 - NAVY BLUE*
- 084 - BRIGHT BLUE

*: Available also as fire resistant

*: Disponibile anche ignifugo

FRAME FINISHES

- 015 - BLACK
- 013 - GREY
- 002 - CHROME

ACCESSORIES

See page 42
Vedi pagina 42

TOSCA WOOD



Shown here in the beech version, Tosca is ideally suited to public institution waiting areas such as clinics, banks and other offices. Tosca is stackable for storing or moving even with arms and/or writing tablets mounted. A transport trolley is available.

Qui proposta nella versione in legno, Tosca è ideale nelle zone d'attesa di strutture ricettive aperte al pubblico come cliniche, banche e uffici in genere. Tosca è comodamente impilabili anche con braccioli e tavoletta. Per facilitarne il trasporto è disponibile anche il carrello.



Metal arms
Braccioli in metallo



Anti-panic tablet
Tavoletta antipanico



Chair stackable up to 10
Sedia impilabile fino a 10

DIMENSIONS

Without arms:

W.56 - D.62 - H.79, H.seat 46 cm

With arms:

W.69 - D.62 - H.79, H.seat 46 cm



TECHNICAL NOTES

- natural varnish plywood seat and back
- 30x15 mm oval steel tube frame
- optional:
 - metal armrests
 - metal linking device
 - anti-panic writing tablet
- *sedile / schienale in legno multistrato verniciato naturale*
- *struttura in tubo d'acciaio ovale 30x15 mm*
- *optional*
 - braccioli in metallo
 - tavoletta scrittoio antipanico
 - agganci in metallo estraibili
 - tavoletta scrittoio antipanico

VARNISHED

011 - NATURAL

FRAME FINISHES

015 - BLACK

013 - GREY

002 - CHROME

ACCESSORIES

See page 43
Vedi pagina 43

MANON



DIMENSIONS

Without arms:

W.50 - D.61 - H.84, H.seat 49 cm

With arms:

W.65 - D.61 - H.84, H.seat 49 cm

The Manon is a multifunctional chair of outstanding comfort thanks to its fully upholstered, ergonomically contoured seat and back supported by a particularly robust and stable tubular steel frame \varnothing 25 mm. The frame is available with or without armrest in three different finishes: black, grey or chrome plated. The seat and back have protective covers in polypropylene.

Manon è una poltrona multifunzionale di eccezionale comfort grazie alla forma ergonomica di sedile e schienale realizzati in poliuretano schiumato a freddo e completamente rivestiti. Il telaio in tubo di acciaio \varnothing 25 mm è disponibile con o senza braccioli. Le finiture disponibili sono: nero, grigio o cromato. Il sedile e lo schienale sono dotati di coperture in polipropilene.

TECHNICAL NOTES

- polypropylene inner/outer back
- polypropylene inner/outer seat
- cold-cure polyurethane foams
- \varnothing 25 mm steel tube, four leg base
- optional base with armrests
- interno/esterno schienale in polipropilene
- interno/esterno sedile in polipropilene
- cuscini in poliuretano schiumato a freddo
- base quattro gambe in tubo d'acciaio \varnothing 25 mm
- base opzionale con braccioli

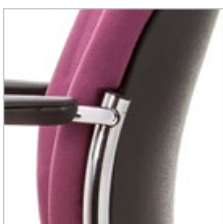

Backrest
Schienale

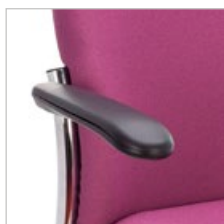

Armrests
Braccioli

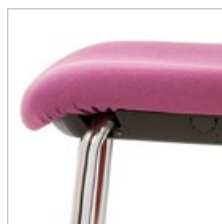

Under seat
Sottoseduta

ANITA



The Anita chair has been designed to adapt to a wide variety of uses and contexts: office and managerial environments, multi-purpose for home and contract. The shell is notable for its modern, functional design, transparent varnish to highlight the natural veins of the beech. Upon request an upholstered panel can be applied just to the seat or to both seat and backrest.

La sedia Anita è stata progettata per adattarsi a diversi tipi di utilizzo nei contesti più svariati: come sedia ospiti in ufficio o in ambienti di tipo professionale, come sedia multifunzionale per il settore casa e contract. La scocca si distingue per lo stile moderno e il design funzionale, verniciata trasparente per esaltare le naturali venature del faggio. A richiesta si può applicare un pannello tappezzato solo per il sedile oppure per il sedile e lo schienale.



Chair with arms v.1
Sedia con braccioli v.1



Chair with arms v.2
Sedia con braccioli v.2



Four leg Chair
Sedia quattro gambe

DIMENSIONS

Without arms:

W.45 - D.52 - H.83, H.seat 45 cm

With arms:

W.55 - D.52 - H.83, H.seat 45 cm



TECHNICAL NOTES

- thick. 12 mm curved plywood shell
- Ø 20 mm steel tube frame
- optional
 - frame with arms
 - upholstered seat panel only
 - upholstered seat and back panel
- scocca in legno multistrato curvato sp. 12 mm
- struttura in tubo d'acciaio Ø 20 mm
- optional
 - struttura con braccioli
 - solo pannello sedile tappezzato
 - pannello sedile e schienale tappezzato

LAQUERED

018 - WHITE

031 - RED

015 - BLACK

VARNISHED

011 - NATURAL

SAMMY



The Sammy chair with a large antipanic tablet is especially suitable for meeting, seminar and conference halls. The plywood shell has the right mix of sturdiness and flexibility to provide a comfortable experience even after many hours of use. Without tablet Sammy can be adopted as an elegant seating for Home and Contract, finished with laquered colours or upholstered in leather or eco-leather.

La sedia Sammy con la sua ampia tavoletta antipanic si presta bene per essere utilizzata durante le riunioni, i seminari e le conferenze. La scocca in legno presenta il giusto mix di flessibilità e resistenza per fornire un'esperienza confortevole anche dopo molte ore di utilizzo. Senza tavoletta Sammy può essere utilizzata come elegante seduta per il settore Casa&Contract, laccata in diversi colori oppure rivestita in pelle o ecopelle.



Natural varnished
Verniciato naturale



Laquered
Laccato



Upholstered
Tapezzato

DIMENSIONS

Without arms:

W.57 - D.56 - H.84, H.seat 45 cm

With arms:



W.60 - D.56 - H.84, H.seat 45 cm



TECHNICAL NOTES

- thick. 12 mm curved plywood shell
- Ø 20 mm steel tube frame
- optional:
 - metal arms
 - antipanic tablet
- *scocca in multistrato curvato sp. 12 mm*
- *struttura in tubo d'acciaio Ø 20 mm*
- *optional*
 - metal arms
 - tavoletta antipanic



LAQUERED

-  018 - WHITE
-  031 - RED
-  015 - BLACK

VARNISHED

-  011 - NATURAL

UPHOLSTERED

-  S01 - LEATHER
-  Q44 - ECO LEATHER

ARCA MESH



Lightweight and very comfortable chair with mesh back available in different colours, with or without armrest, Arca chair is always stackable. Steel tube frame \varnothing 18 mm available in three different finishes: black, grey or chrome plated.

Sedia ospiti dalla struttura leggera e di grande comfort con schienale in rete disponibile in diversi colori, con braccioli o senza, la sedia Arca è sempre impilabile. Il telaio è realizzato in tubo d'acciaio \varnothing 18 mm disponibile in tre diverse finiture: nero, grigio o cromato.



Mesh back
Schienale in rete

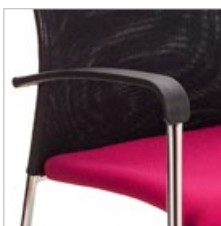

Armrests
Braccioli

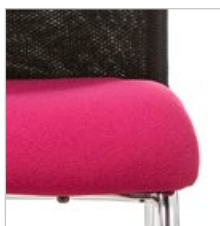

Upholstered seat
Sedile tappezzato

DIMENSIONS

Without arms:

W.47 - D.58 - H.81, H.seat 45 cm

With arms:

W.56 - D.58 - H.81, H.seat 45 cm



TECHNICAL NOTES

- mesh back with metal frame
- polypropylene seat to upholsterer
- \varnothing 18 mm steel tube, four leg base
- optional polypropylene armrests
- schienale in rete con telaio in metallo
- sedile in polipropilene da tappezzare
- base quattro gambe in tubo di acciaio \varnothing 18 mm
- braccioli in polipropilene opzionali

FRAME FINISHES

- 015 - BLACK
- 013 - GREY
- 002 - CHROME

ARCA



Lightweight and very comfortable chair with upholstered back, available with or without armrest, Arca chair is always stackable. Steel tube frame \varnothing 18 mm available in three different finishes: black, grey or chrome plated.

Sedia ospiti dalla struttura leggera e di grande comfort con schienale imbottito, disponibile con braccioli o senza, la sedia Arca è sempre impilabile. Il telaio è realizzato in tubo d'acciaio \varnothing 18 mm disponibile in tre diverse finiture: nero, grigio o cromato.



Upholstered back
Schienale imbottito

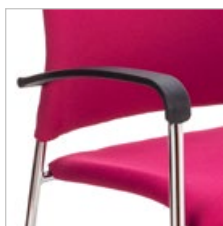

Armrests
Braccioli

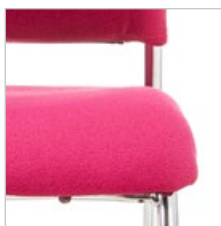

Upholstered seat
Sedile imbottito

DIMENSIONS

Without arms:

W.47 - D.58 - H.81, H.seat 45 cm

With arms:

W.56 - D.58 - H.81, H.seat 45 cm



TECHNICAL NOTES

- plywood back to upholsterer
- polypropylene seat to upholsterer
- \varnothing 18 mm steel tube, four leg base
- optional polypropylene armrests
- *schienale in legno multistrato da tappezzare*
- *sedile in polipropilene da tappezzare*
- *base quattro gambe in tubo d'acciaio \varnothing 18 mm*
- *braccioli opzionali in polipropilene*

FRAME FINISHES

-  015 - BLACK
-  013 - GREY
-  002 - CHROME

AMBA



This is the ideal chair for lecture halls, auditoriums, meeting rooms or eating areas. Its look is elegantly clean and simple, yet its dimensions and contours guarantee comfort. The lightweight Amba is easy to move and easy to stack, with or without arms. A choice of accessories include a writing tablet and a document tray.

Leggera ed agile sedia multifunzionale, ideale per sale conferenza, auditorium, sale riunione e aree di ristoro. Il suo aspetto è elegante e minimalista ma al tempo stesso comoda grazie alle sue dimensioni e alla forma ergonomica. Amba, nella sua leggerezza, è molto facile da spostare e da impilare, con e senza braccioli.



Four leg chair
Sedia 4 gambe



Chair with tablet
Sedie con tavoletta



Trolley - chair stackable up to 10
Carrello - sedia impilabile fino a 10

DIMENSIONS

Without arms:

W.47 - D.58 - H.81, H.seat 45 cm

With arms:

W.56 - D.58 - H.81, H.seat 45 cm



TECHNICAL NOTES

- polipropylene seat and back
- Ø 16 mm steel tube frame
- optional:
 - polipropylene linking device
 - writing tablet
 - document tray
- *sedile e schienale in polipropilene*
- *struttura in tubo d'acciaio Ø 16 mm*
- *optional*
 - *agganci in polipropilene*
 - *tavoletta scrittoio*
 - *cestello porta riviste*

PLASTIC COLOURS

- 015 - BLACK
- 079 - DARK GREY
- 073 - LIGHT GREY
- 028 - GREEN
- 038 - ORANGE
- 031 - RED
- 042 - BORDEAUX
- 054 - NAVY BLUE
- 084 - BRIGHT BLUE

FRAME FINISHES

- 015 - BLACK
- 013 - GREY
- 002 - CHROME

ACCESSORIES

See page 43
Vedi pagina 43

JIM



Lightweight yet distinctive and fluid in its design, Jim has a colorful polypropylene shell that can be enriched by a soft panel for the seat. As more sophisticated alternative is available a natural varnished wooden shell.

Sedia leggera, dalle linee fluide ma di forte personalità, Jim ha una scocca in polipropilene colorato che può essere arricchita da un morbido cuscino per il sedile. Come alternativa più sofisticata è disponibile la scocca in legno verniciata naturale.



Polypropylene shell
Scocca in polipropilene



Wooden shell
Scocca in legno



Stackable
Impilabile

DIMENSIONS

W.57 - D.50 - H.82, H.seat 47 cm



TECHNICAL NOTES

- polypropylene shell with optional seat cushion
- thick. 12 mm curved plywood shell
- Ø 20 mm steel tube chrome plated frame
- scocca in polipropilene con pannello sedile opzionale
- scocca in legno multistrato curvato sp. 12 mm
- struttura cromata in tubo d'acciaio Ø 20 mm

PLASTIC COLOURS

- 018 - WHITE
- 013 - SKY BLUE
- 028 - GREEN
- 029 - PINK
- 038 - ORANGE
- 031 - RED
- 021 - ANTHRACITE

VARNISHED

- 011 - NATURAL

KAI



The Kai chair epitomises lightweight and elegant simplicity. Ergonomically contoured, polypropylene shell on a four legged chrome plated base. Available with or without armrest.

La sedia Kai è sinonimo di leggerezza ed eleganza minimalista. Scocca in polipropilene con profilo ergonomico su una base cromata a quattro gambe. Disponibile con o senza braccioli.

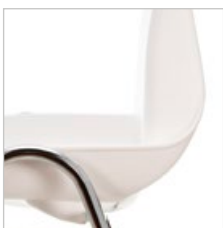

Frame without arms
Struttura senza braccioli

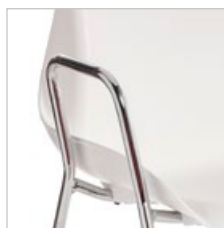

Frame with arms
Struttura con braccioli

DIMENSIONS

Without arms:

W.56 - D.50 - H.79, H.seat 45 cm

With arms:

W.66 - D.50 - H.79, H.seat 45 cm



TECHNICAL NOTES

- polypropylene shell
- Ø 20 mm steel tube frame
- *scocca in polipropilene*
- *struttura in tubo d'acciaio Ø 20 mm*

COLOURS

-  018 - WHITE
-  015 - BLACK
-  079 - DARK GREY
-  073 - LIGHT GREY
-  054 - BLUE NAVY

DIRECTOR



Its precise and elegant lines plus the folding system are the key elements of this stylish seat; a resilient chair capable to adapt to either classy situations and informal happenings.

Director's chair perfectly integrates with corporate, cultural and academic events, as well as hotels or restaurants. Suitable both for indoor and outdoor use.

Le sue linee precise ed eleganti e la praticità della struttura pieghevole caratterizzano lo stile e l'armonia di questa seduta, rendendola una sedia resiliente, capace di adeguarsi alle situazioni più eleganti come a quelle più informali.

La sedia Regista si integra infatti perfettamente anche nell'ambito di eventi istituzionali, accademici e culturali, in hotel e ristoranti. Adatta per essere utilizzata sia in spazi coperti sia all'aperto.

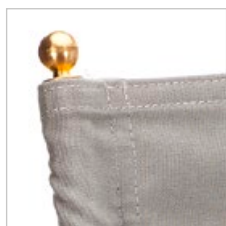

Solid brass details
Puntali in ottone



Solid brass details
Puntali in ottone

DIMENSIONS

W.50/11 - D.52 - H.85
H.seat 42 cm



TECHNICAL NOTES

- \varnothing 20 mm epoxy coated steel tube with solid brass details
- seat and back removable fabric
- polypropylene caps
- struttura verniciata in tubo di acciaio \varnothing 20 mm con puntali in ottone massello
- sedile e schienale con rivestimento rimovibile
- puntali in polipropilene

BEAM SEATING





TOSCA BEAM



Upholstered seats
Sedili tappezzati

For larger waiting areas the beam version of Tosca provides a solution of elegant and essential design. Available with 2, 3 or 4 seats and backs in polypropylene or beech finish to suit public spaces, or upholstered for more private areas.

Costruita per ampie zone d'attesa, la versione con trave della Tosca fornisce una soluzione elegante ed essenziale. È disponibile con 2, 3 o 4 posti, in plastica, in legno per adattarsi agli ambienti pubblici, o imbottita per le aree private.



Plastic seats with metal arms
Sedili in plastica con braccioli in metallo



Wooden seats with plastic arms
Sedili in legno con braccioli in plastica

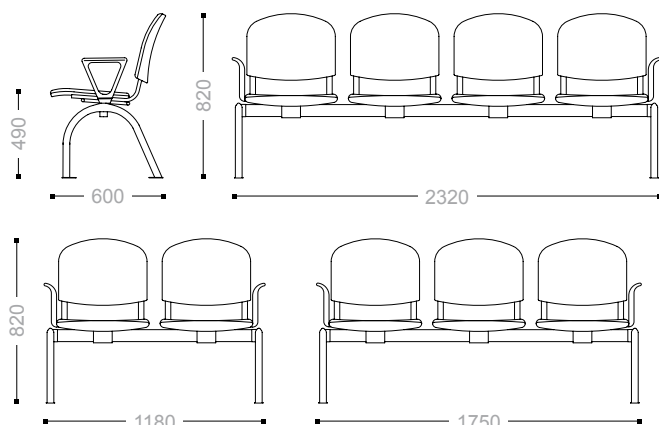

TECHNICAL NOTES

- 80x40 mm steel tube beam
- Ø 40 mm steel tube curved legs
- optional
 - polypropylene armrests
 - metal armrests
 - anti-panic writing tablet
- trave in tubo d'acciaio 80x40mm
- gambe curva in tubo d'acciaio Ø 40 mm
- optional
 - braccioli in polipropilene
 - braccioli in metallo
 - tavoletta scrittoio antipanico

PLASTIC COLOURS

- 042 - BORDEAUX
- 031 - RED
- 079 - DARK GREY
- 015 - BLACK
- 073 - LIGHT GREY*
- 054 - NAVY BLUE*
- 084 - BRIGHT BLUE

*: Available also as fire resistant
*: Disponibile anche ignifugo

VARNISHED

- 011 - NATURAL

FRAME FINISHES

- 015 - BLACK
- 013 - GREY
- 002 - CHROME

ACCESSORIES

See page 42
Vedi pagina 42

TURANDOT BEAM

The bench version is available with 2, 3 or 4 seats and can include end or intermediate table. End arms can be added, or intermediate arms complete with writing tablets.

La versione con panca è disponibile con 2, 3 o 4 posti e può includere tavolini intermedi o da posizionare alle estremità e braccioli, completi di tavoletta per scrittura.



Upholstered seats
Sedili tappezzati



Plastic seats
Sedili in plastica

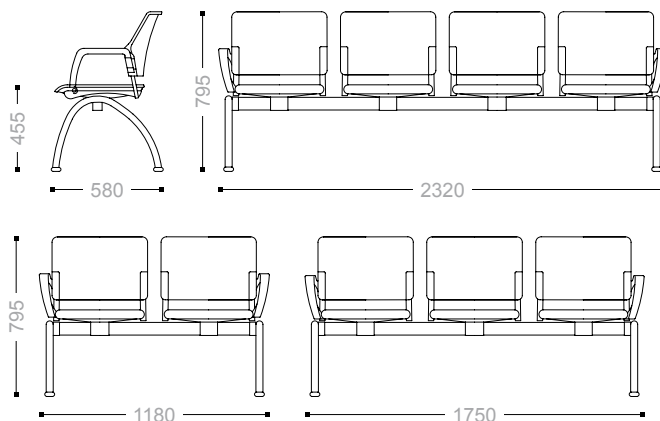

TECHNICAL NOTES

- 80x40 mm steel tube beam
- \varnothing 40 mm steel tube curved legs
- optional
 - polypropylene armrests
 - metal armrests
 - anti-panic writing tablet
- *trave in tubo d'acciaio 80x40 mm*
- *gambe curva in tubo d'acciaio \varnothing 40 mm*
- optional
 - braccioli in polipropilene
 - braccioli in metallo
 - tavoletta scrittoio antipanico

PLASTIC COLOURS

- 015 - BLACK
- 073 - LIGHT GREY

FRAME FINISHES

- 015 - BLACK
- 013 - GREY
- 002 - CHROME

ACCESSORIES

See page 43
Vedi pagina 43

TESS BEAM

The design of the Tess has been carefully studied in every detail to maximise its clean distinctive lines: Un upholstered seat panel is available to have a more comfortable seat.

Il design della panca Tess è stato accuratamente studiato in ogni dettaglio per ottimizzare le linee "pulite" che la contraddistinguono. Un pannello sedile opzionale è disponibile per rendere la seduta più confortevole.



Four seater beam
Panca a quattro posti



Three seater beam
Panca a tre posti



Two seater beam
Panca a due posti

TECHNICAL NOTES

- 80x40 mm steel tube beam
- Ø 40 mm steel tube curved legs
- optional seat panel
- *trave in tubo d'acciaio 80x40 mm*
- *gambe curva in tubo d'acciaio Ø 40 mm*
- *pannello sedile opzionale*

PLASTIC COLOURS

- 018 - WHITE
- 073 - LIGHT GREY
- 030 - GRAPHITE
- 021 - ANTHRACITE
- 013 - LIGHT BLUE
- 028 - GREEN
- 038 - ORANGE
- 031 - RED
- 003 - CRETE
- 004 - PURPLE

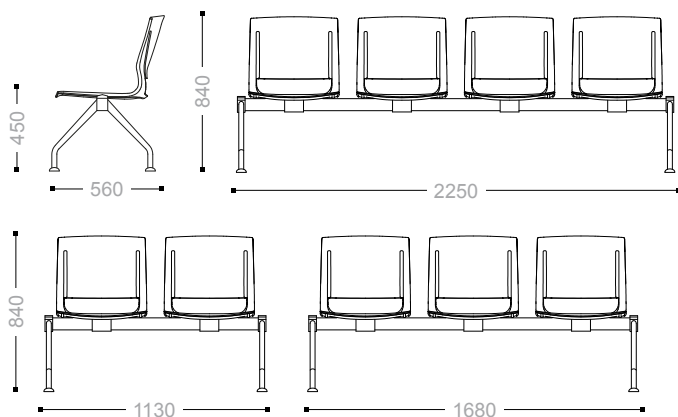



TOSCA ACCESSORIES



SH480QR15
(right/destro)
SH480QL15
(left/sinistro)

Metal arm with joint 14x14 mm - black.
Bracciolo in metallo con perno 14x14 mm - black.



SH480QR13
(right/destro)
SH480QL13
(left/sinistro)

Metal arm with joint 14x14 mm - grey.
Bracciolo in metallo con perno 14x14 mm - grigio.



SH480QR02
(right/destro)
SH480QL02
(left/sinistro)

Metal arm with joint 14x14 mm - chrome.
Bracciolo in metallo con perno 14x14 mm - cromato.



SH480TR15
(right/destro)
SH480TL15
(left/sinistro)

Metal arm with joint \varnothing 16 mm - black.
Bracciolo in metallo con perno \varnothing 16 mm - black.



SH480TR13
(right/destro)
SH480TL13
(left/sinistro)

Metal arm with joint \varnothing 16 mm - grey.
Bracciolo in metallo con perno \varnothing 16 mm - grigio.



SH480TR02
(right/destro)
SH480TL02
(left/sinistro)

Metal arm with joint \varnothing 16 mm - chrome.
Bracciolo in metallo con perno \varnothing 16 mm - cromato.



SH4803015
Ambidextrous metal arm - black.
Bracciolo ambidestro in metallo - nero.



SH4803013
Ambidextrous metal arm - grey.
Bracciolo ambidestro in metallo - grigio.



SH4803002
Ambidextrous metal arm - chrome.
Bracciolo ambidestro in metallo - cromato.



SH4762015
Ambidextrous plastic arm - black.
Bracciolo ambidestro in plastica - nero.



LP9051R15
(right/destro)
LP9051L15
(left/sinistro)

Antipanic tablet with Aluminium joint \varnothing 16 mm.
Tavoletta antipanico con snodo in alluminio \varnothing 16 mm.



LP9151R15
(right/destro)
LP9151L15
(left/sinistro)

Antipanic tablet with nylon joint 14x14 mm.
Tavoletta antipanico con snodo in nylon 14x14 mm.



LT4762002
Document tray - chrome.
Cestello portariviste - cromato.



FD4762015
(black/nero)
FD4762013
(grey/grigio)
FD4762002
(chromed/cromato)

Metal linking device.
Aggancio in metallo estraibili.



LS4802015
Metal trolley for stacking chairs.
Carrello in metallo per il trasporto delle sedie impilate.

TURANDOT ACCESSORIES



SH477TR15
(right/*destro*)
SH477TL15
(left/*sinistro*)

Metal arm with joint \varnothing 16 mm - black.
Bracciolo in metallo con perno \varnothing 16 mm - black.



SH477TR13
(right/*destro*)
SH477TL13
(left/*sinistro*)

Metal arm with joint \varnothing 16 mm - grey.
Bracciolo in metallo con perno \varnothing 16 mm - grigio.



SH477TR02
(right/*destro*)
SH477TL02
(left/*sinistro*)

Metal arm with joint \varnothing 16 mm - chrome.
Bracciolo in metallo con perno \varnothing 16 mm - cromato.



SH4773R15
(right/*destro*)
SH4773L15
(left/*sinistro*)

Metal arm - black.
Bracciolo in metallo - black.



SH4773R13
(right/*destro*)
SH4773L13
(left/*sinistro*)

Metal arm - grey.
Bracciolo in metallo - grigio.



SH4773R02
(right/*destro*)
SH4773L02
(left/*sinistro*)

Metal arm - chrome.
Bracciolo in metallo - cromato.



SH4772R15
(right/*destro*)
SH4772L15
(left/*sinistro*)

Plastic arm - black.
Bracciolo in plastica - black.



SH4772R73
(right/*destro*)
SH4772L73
(left/*sinistro*)

Plastic arm - grey.
Bracciolo in plastica - grigio.



LP9051R15
(right/*destro*)
LP9051L15
(left/*sinistro*)

Antipanic tablet with Aluminium joint \varnothing 16 mm.
Tavoletta antipanico con snodo in alluminio \varnothing 16 mm.



FD4772015
Platic linking device.
Aggancio in plastica.



LS4802015
Metal trolley for stacking chairs.
Carrello in metallo per il trasporto delle sedie impilate.

AMBA ACCESSORIES



LT4742002
Document tray - chrome.
Cestello portariviste - cromato.



KH2922R02
(right/*destro*)
KH2922L02
(left/*sinistro*)

Writing tablet with polyuretane edge - chrome support.
Tavoletta scrittoio con bordo gommato - supporto cromato.



LS4802015
Metal trolley for stacking chairs.
Carrello in metallo per il trasporto delle sedie impilate.



FB9302015
Platic linking device.
Aggancio in plastica.

WRITING TABLETS



LP9151R15
(337 x 263 mm)

Antipanic tablet in ABS with nylon attachment 14x14 mm.
Tavoletta antipanic in ABS con snodo in nylon 14x14 mm.



LP9052R15
(335 x 265 mm)

Antipanic tablet in ABS with aluminium attachment 14x14 mm.
Tavoletta antipanic in ABS con snodo in alluminio 14x14 mm.



LP9051R15
(335 x 265 mm)

Antipanic tablet in ABS with aluminium attachment \varnothing 16 mm.
Tavoletta antipanic in ABS con snodo in alluminio \varnothing 16 mm.



KH2922R02
(524 x 298 mm)

Writing tablet with polyuretane edge - chrome support.
Tavoletta scrittoio con bordo gommato - supporto cromato.

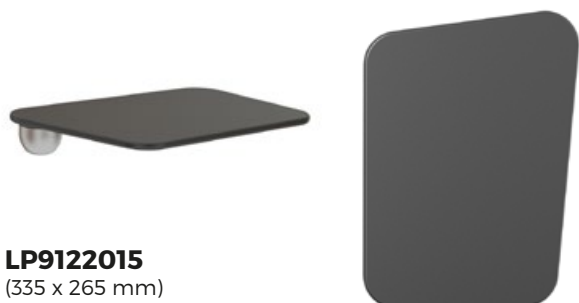

LP9122015
(335 x 265 mm)

Antipanic tablet in ABS with aluminium attachment \varnothing 16 mm.
Tavoletta antipanic in ABS con snodo in alluminio \varnothing 16 mm.

TROLLEY



LS4802015
Metal trolley for stacking chairs.
Carrello in metallo per il trasporto delle sedie impilate.



Mar.c.a. Design

Via Montegrappa 77 - 31010 Fonte - TV
tel: +39 345 5311824
email: info@arredoufficiomarca.com
www.arredoufficiomarca.com

